





# WELCOME TO FLEETWOOD

## Before You Begin

We are proud of our 62+ year history as a California-based window and door manufacturer. In a time when others are making products in foreign countries, Fleetwood remains true to its essential purpose as an American company, employing American workers making quality products.

We believe we are helping support the American dream of success by relying upon this country's ingenuity and work ethic, which has made the United States of America the greatest country in the world. Our focus is to innovate, not imitate.

You will discover that we continue to blaze a trail of top quality and innovative design, like our patented Archetype Locking System.

We appreciate the amount of time it takes to properly research windows and doors. We believe you will discover that Fleetwood offers much more value than any other window and door company. If possible, visit our factory or a dealer showroom. Once you have operated one of our life size doors (the bigger the better!) you will understand our reputation.

## TABLE OF CONTENTS

### General

The Little Things	Page
Benefits Of Aluminum	2
Sustainability	3
Factory & Showroom	48
	49

### Doors

Content	Page
Multi-Slide/Pocket	Series 4070-T Thermal Frame 6-7
Multi-Slide/Pocket	Series 3070-T Thermal Frame 8-9
Multi-Slide/Pocket	Series 3070 10-11
Multi-Slide/Pocket	Series 3050 12-13
Traditional Sliding	Series 3000-T Thermal Frame 14-15
Traditional Sliding	Series 3000 16-17
Pivot Door	Series 4400-T Thermal Frame 20-21
Hinged Door	Series 3900-T Thermal Frame 22-23
Hinged Door	Series 3200-T Thermal Frame 24-25
Folding Door	Series 3600-T Thermal Frame 26-27

### Windows

Content	Page
Casement, Awning, Hopper, Fixed	Series 450-T Thermal Frame 30-31
Casement, Awning, Hopper, Fixed	Series 350-T Thermal Frame 32-33
Window-Wall Fixed System	Series 3800-T Thermal Frame 34-35
Horizontal Slider, Fixed	Series 330-T Thermal Frame 36-37

### Product Options

Door Hardware	Page
Window Hardware	38-39
Aluminum Finishes	40-41
	42-43

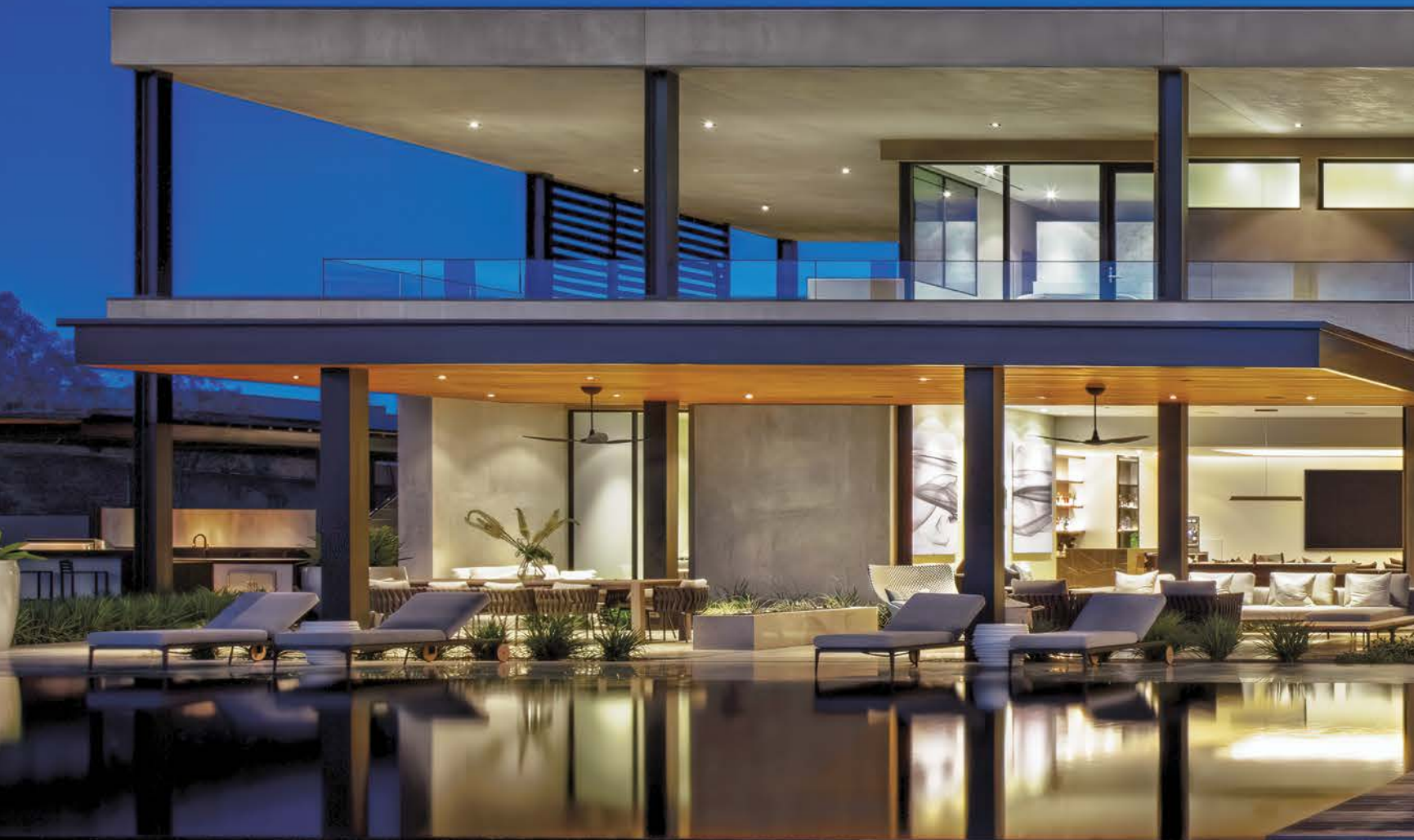



# THE “LITTLE” THINGS



## ARCHETYPE ROLLING SYSTEM

Fleetwood designed and made in the USA with **certified Swiss** precision bearings and European 440C stainless steel. Hand assembled using SPC (Statistical Process Control) and visually inspected. Strict proprietary tolerances achieved only by world class bearing manufacturers.

58 HRC (Rockwell Hardness) bearings compared to 40 HRC industry standards (below 52 creates metallic particles acting as a grinding paste). Each bearing contains a special low friction contact seal with lifetime lubricant. All rollers come with a lifetime warranty. For more information, ask our dealer for a copy of *Archetype Rolling System*.

## ARCHETYPE & ARCHETYPE NARROW LOCKING SYSTEM

Made in the USA from high-grade stainless steel. The faceplates are constructed of #300 stainless steel and then electropolished for the highest possible coastal protection. The latch hook(s) are comprised of laminated 6 ply stainless steel and each pull is cast with #316 stainless steel and electropolished. For more information, ask our dealer for a copy of the *Archetype Locking System* document.



# BENEFITS OF ALUMINUM

THERE ARE NUMEROUS REASONS TO CHOOSE ALUMINUM WINDOWS AND DOORS.



## CRISP, LINEAR SHAPES

Aluminum can easily be designed with great intricacy, which provides narrow sightlines, allowing the door or window to blend into the architecture rather than overpower it. For example, the Series 3070 is available 18' tall and the vertical sightline is ONLY 2-1/16".

## LOW MAINTENANCE

Without question, aluminum is the most durable and easily maintained window and door material. We encourage you to review our *Care & Maintenance Instructions*, as well as our *Lifetime Warranty*.

## FIRE HEAT RESISTANCE

Products designed to resist the impingement of flames are often made of steel, which has limits in function and design. In contrast, aluminum, though not fire proof, offers diverse design elements with practical fire performance. Extruded aluminum retains its form at over 1000°F and is non-combustible. Heat and flames quickly destroy most other windows. The urban wild fire building codes are addressing some of these practical realities and seem to be leaning toward aluminum or steel as the preferred building material.

## IMPACT PRODUCT LINE

Fleetwood offers a product line designed for markets requiring impact tested products. For more information, visit the *Products* section online.



## ENERGY COMPLIANCE

The **SHGC** measures heat gain based on direct sun exposure. The lower the number, the less heat (short wave radiation) passes through the window or door. Sunbelt climates should make this value a high priority.

The **U-Factor** measures heat lost through the window or door. Be careful not to apply too much importance to this factor because **the test is done with all seams taped shut**. For more information, see 'Making the Right Choices' on our website.

- **NFRC Test Result:**  
Online test results for each product. Quotes include product and glass specific SHGC and U-Factor numbers.
- **Weighted Average(s) Per Job:**  
NFRC data averages provided with each quote.
- **Custom Analysis:**  
Using the same software as the NFRC, Fleetwood provides a true energy result of each custom opening (expect an improvement of 5%–20%).



# SLIDING DOORS



ARCHITECT  
Landry Design Group  
PHOTO  
Manolo Langis



# SERIES 4070-T

MULTI-SLIDE & POCKET DOOR



## MINIMAL

The 4070-T was designed with two primary intentions: large sizes and a weather performing flush sill. The patented Arche-Duct is a highly engineered sub floor draining system, which creates a minimal footprint in the finished floor yet still achieves water, air, and energy ratings for residential use.

## MASSIVE YET SLIM

The 4070-T is available in 120 square foot panels, which can weigh up to 1400 lbs. While achieving the unequaled strength necessary to support these panels, the 4070-T still presents a sleek 2-1/2" vertical sightline and a short bottom rail at 3-1/4" tall.

## SMART BUILDING DESIGN

Field conditions were factored into the design of this exceptional door. For instance, the glass can be vertically set during later stages of construction to protect it and facilitate the progress of other trades. Additionally, the patented sill is shipped with a cover for the tracks and linear drain for protection during finished floor installation.

## PROPRIETARY HARDWARE

The 4070-T is outfitted with Fleetwood designed and manufactured hardware. The A4 roller may resemble copycat rollers in the mass production market but only the A4 uses certified Swiss precision bearings. The slender locking hardware is our patented (Patent # US 8,186,189 B2) Archetype Narrow.

### CONFIGURATIONS

■ Virtually Unlimited Multi-Slide, Pocket and Corner applications.

← MAX PANEL WIDTH	↑ MAX FRAME HEIGHT	☀ EXAMPLE SHGC	❄ EXAMPLE U-FACTOR
12'	20'	<sup>2</sup> NFRC 0.21   <sup>3</sup> S.P.A. 0.24	<sup>2</sup> NFRC 0.35   <sup>3</sup> S.P.A. 0.28

Elevation View:  
XXX Configuration

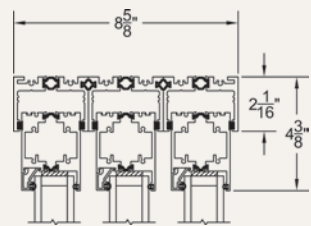

Head

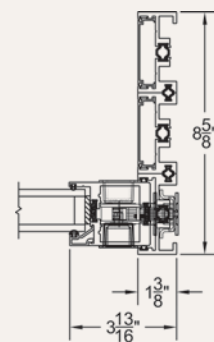
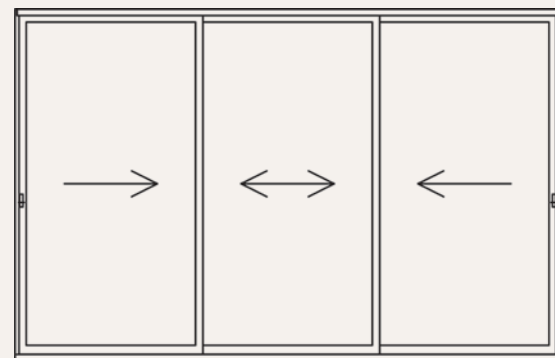

Lock Jamb

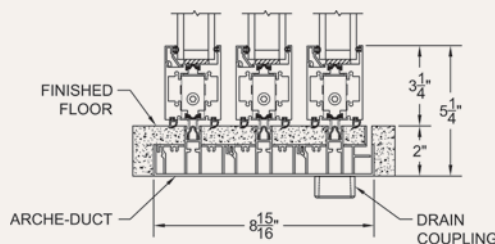

Sill

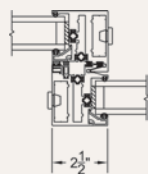

Interlockers

<sup>1</sup>Max width and height are not necessarily available in combination.

<sup>2</sup>Specimen size: Nom. 79" x 79".

<sup>3</sup>Simulated Performance Alternative size: 216" x 144" XXX using Cardinal 366-i89/Argon glass.



# SERIES 3070-T

MULTI-SLIDE & POCKET DOOR



H&S International  
Architect  
McCall Media

## TYPICAL CONFIGURATIONS

Virtually Unlimited Multi-Slide, Pocket and Corner applications.

MAX PANEL WIDTH	MAX FRAME HEIGHT	EXAMPLE SHGC	EXAMPLE U-FACTOR
8'	12'	<sup>2</sup> NFRC 0.21   <sup>3</sup> S.P.A. 0.22	<sup>2</sup> NFRC 0.31   <sup>3</sup> S.P.A. 0.29

Elevation View:  
OXX Configuration

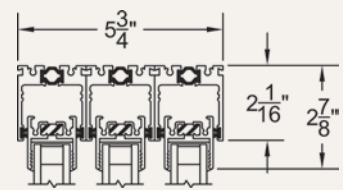

Head

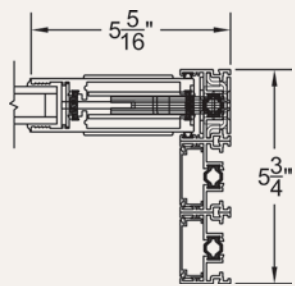
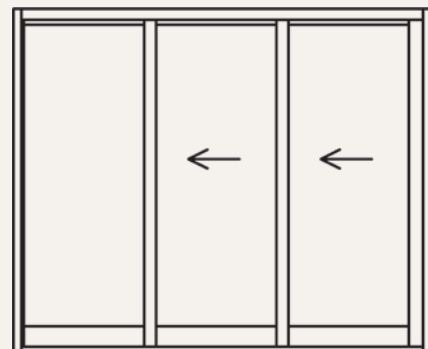

Lock Jamb

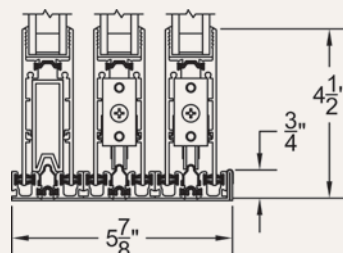

Sill

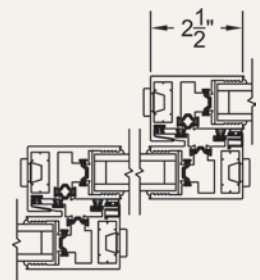

Interlockers

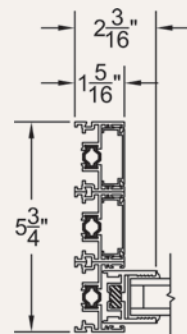

Fixed Jamb



## MINIMALIST HARDWARE

The standard locking system for the 3070-T is our patented Archetype system. For those desiring even more glass, we offer the optional Archetype Narrow, which is the same latch as the Archetype but with vertical actuation and a thinner profile of 3.25".



## FROST CLIMATE EXTRUSIONS

The 3070-T was designed to emulate the Series 3070, but with added accommodations for colder climates. Each aluminum extrusion includes an integral thermal barrier that reduces thermal conduction of the exterior temperature to the interior. The resulting door system boasts energy performance that complies with some of the strictest energy codes in North America and retains a highly attractive aesthetic.

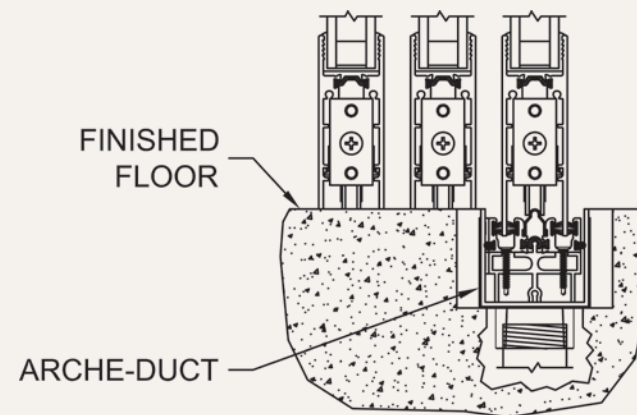

## ARCHE-DUCT DRAINING SYSTEM

The Arche-Duct is proprietary to Fleetwood. This system allows for flush flooring and hurricane water performance. Customers may choose a continuous track or a staggered design, as shown here. Builders appreciate the threaded drain couplings, which offer a variety of placement options.



## NO POST CORNER

Custom extrusions were created to allow 90° corner doors as well as odd angle corner doors without the need for a post or jamb. The result is the strongest and most attractive corner door on the market. Imagine the accentuation of your stunning view as you maximize space and minimize barriers between the inside and outside.

<sup>1</sup>Max width and height are not necessarily available in combination.

<sup>2</sup>Specimen size: Nom. 79" x 79".

<sup>3</sup>Simulated Performance Alternative size: 120" x 144" OXX using Cardinal 366-i89/Argon glass.



# SERIES 3070

MULTI-SLIDE & POCKET DOOR



## ATTENTION TO DETAIL

The 3070 is loaded with features that accentuate its beauty and purposeful design. For example, the frame fillers conceal the installation screws, enhance weather performance, and guard against sand, dirt, and debris.



## CUSTOMIZABLE FEATURES

The 3070 can be customized to accommodate a wide variety of aesthetics and purposes. For example, both of the lock stile choices offer unique design and ergonomics based on our patented Archetype technology.



## TYPICAL CONFIGURATIONS

Virtually Unlimited Multi-Slide, Pocket and Corner applications.

MAX PANEL WIDTH	MAX FRAME HEIGHT	EXAMPLE SHGC		EXAMPLE U-FACTOR	
10'	18'	<sup>2</sup> NFRC 0.22	<sup>3</sup> S.P.A. 0.24	<sup>2</sup> NFRC 0.47	<sup>3</sup> S.P.A. 0.32

Elevation View:  
OXXX Configuration

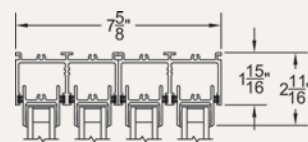
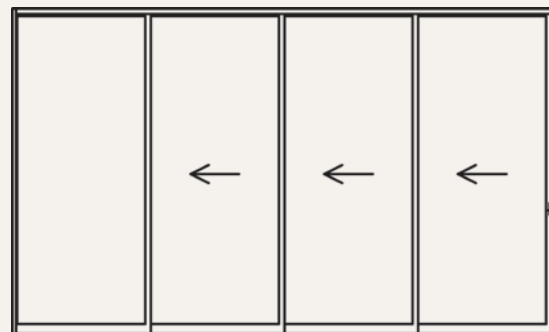

Head

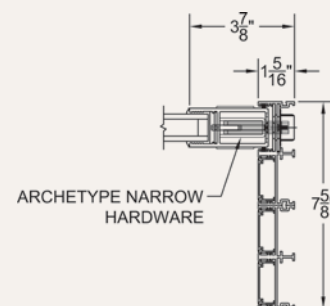

Lock Jamb

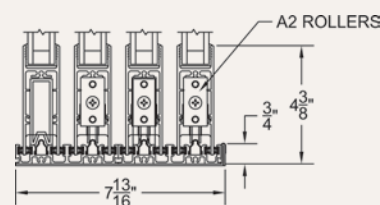

Sill

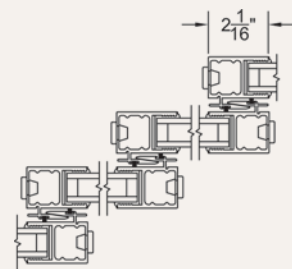

Interlockers

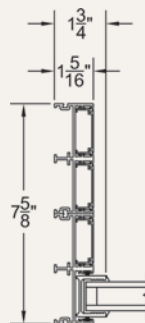

Fixed Jamb

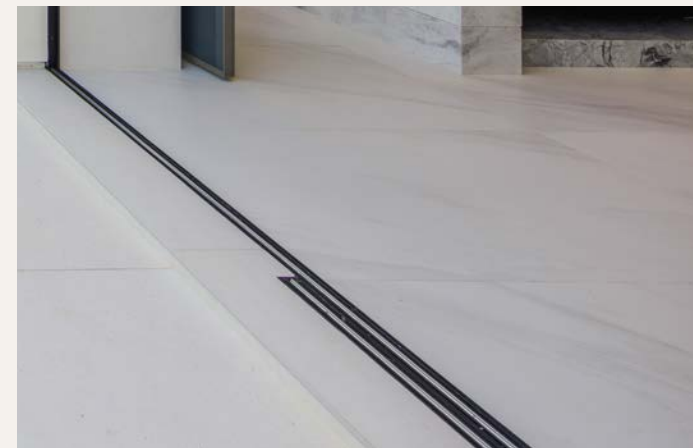

## WEATHER RATED FLUSH SILL

The optional Arche-Duct draining system allows for a continuous finished floor, similar to the Series 3050 Hidden Track, but with tested weather performance. The staggered Arche-Duct can also achieve up to hurricane-grade water performance.

## DESIGN FLEXIBILITY

Be limited only by your imagination and stay true to the design intent with virtually unlimited choices in panel arrangement. The 3070's robust offering includes: no-post inside and outside custom angle corners, pocketing systems, and traditional configurations.



<sup>1</sup>Max width and height are not necessarily available in combination.

<sup>2</sup>Specimen size: Nom. 79" x 79".

<sup>3</sup>Simulated Performance Alternative size: 288" x 130" OXXX using SNX62/27-IS20/Argon Warm Edge glass.



# SERIES 3050

MULTI-SLIDE & POCKET DOOR



ARCHITECT  
Blue Heron  
PHOTO  
Gary Kashi

## CONFIGURATIONS

Virtually Unlimited Multi-Slide, Pocket and Corner applications.

← MAX PANEL WIDTH	↑ MAX FRAME HEIGHT	EXAMPLE SHGC		EXAMPLE U-FACTOR	
10'	18'	<sup>2</sup> NFRC 0.22	<sup>3</sup> S.P.A. 0.23	<sup>2</sup> NFRC 0.47	<sup>3</sup> S.P.A. 0.39

Elevation View:  
PXIXP with Screens Configuration

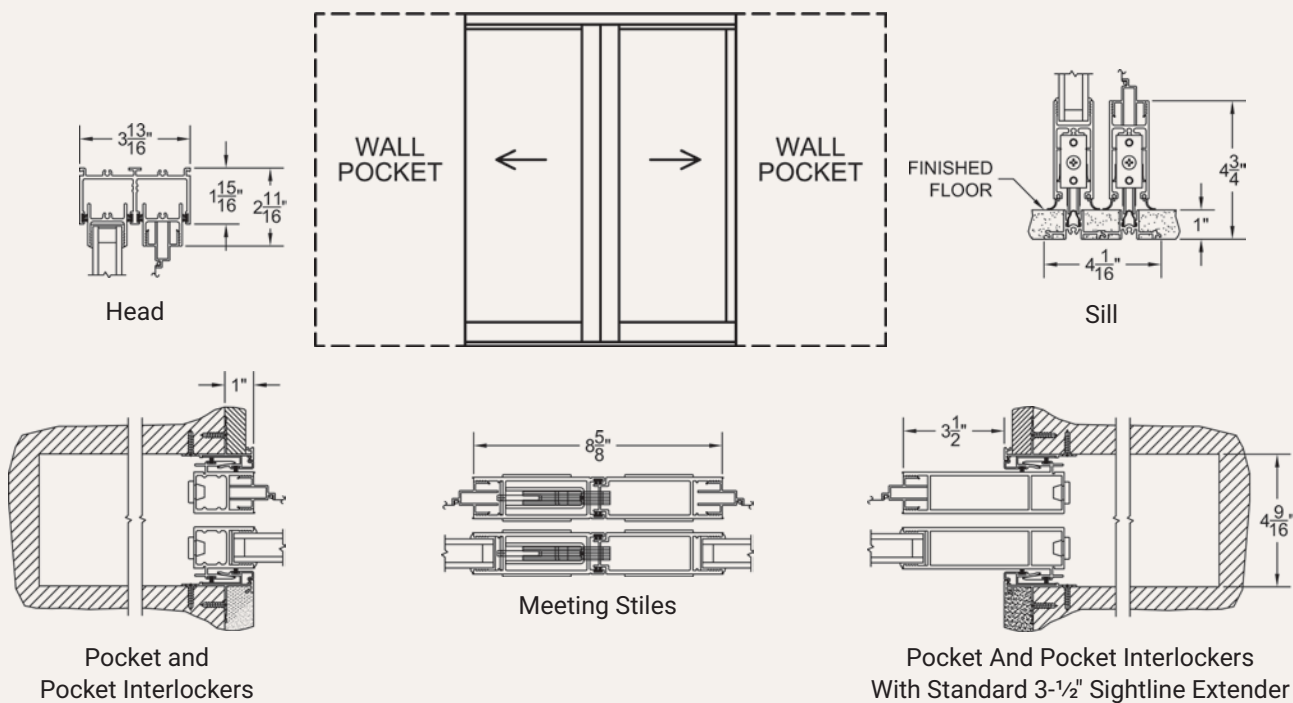

<sup>1</sup>Max width and height are not necessarily available in combination.

<sup>2</sup>Specimen size: Nom. 79" x 79".

<sup>3</sup>Simulated Performance Alternative size: 120" x 144" PXIXP using Cardinal 366-i89/Argon glass.



## EXTENDED LIVING SPACE

The 3050 is a special variant of the Series 3070 as it offers a unique sill. The "Hidden Track" creates an almost invisible transition from the interior to the exterior, while offering modest energy and air performance. For higher performing weather and energy needs, consider the Series 4070-T, 3070 or 3070-T doors.

## VERSATILE APPLICATIONS

Primarily designed for interior applications, the 3050 is a contemporary lifestyle door, ideal for interior pocket doors, room dividers, and pass-through counters. The completely recessed track provides an ultra clean and unobtrusive appearance at the floor. The panel profiles are the same as our exterior rated sliding doors, allowing for a unified design throughout the home.

## EXCEPTIONAL HARDWARE

All Fleetwood sliding doors come equipped with Fleetwood's proprietary Archetype locking & sliding systems, proudly made in the USA. Our patented locking hardware is offered in two stile widths: Archetype and Archetype Narrow and both are available in brushed stainless or black finishes. Our A2 roller is equipped with certified Swiss precision bearings and is crafted from high-grade stainless steel.

## CURVED SLIDING DOORS

Fleetwood stands alone in our capability to provide curved sliding glass walls. Our state-of-the-art Delta 60 CNC-I roll bender offers curved doors with a radius as tight as 12' and unlimited widths.



# SERIES 3000-T

## SLIDING DOOR



SHED Architecture  
ARCHITECT  
Rafael Sotillo

### TYPICAL CONFIGURATIONS

OX, XO, OXO, OOX, XOO, XOX, OXXO, XOOX.

MAX PANEL WIDTH	MAX FRAME HEIGHT	EXAMPLE SHGC	EXAMPLE U-FACTOR
6'	12'	<sup>2</sup> NFRC 0.21   <sup>3</sup> S.P.A. 0.23	<sup>2</sup> NFRC 0.36   <sup>3</sup> S.P.A. 0.28

Elevation View:  
OXIXO Configuration

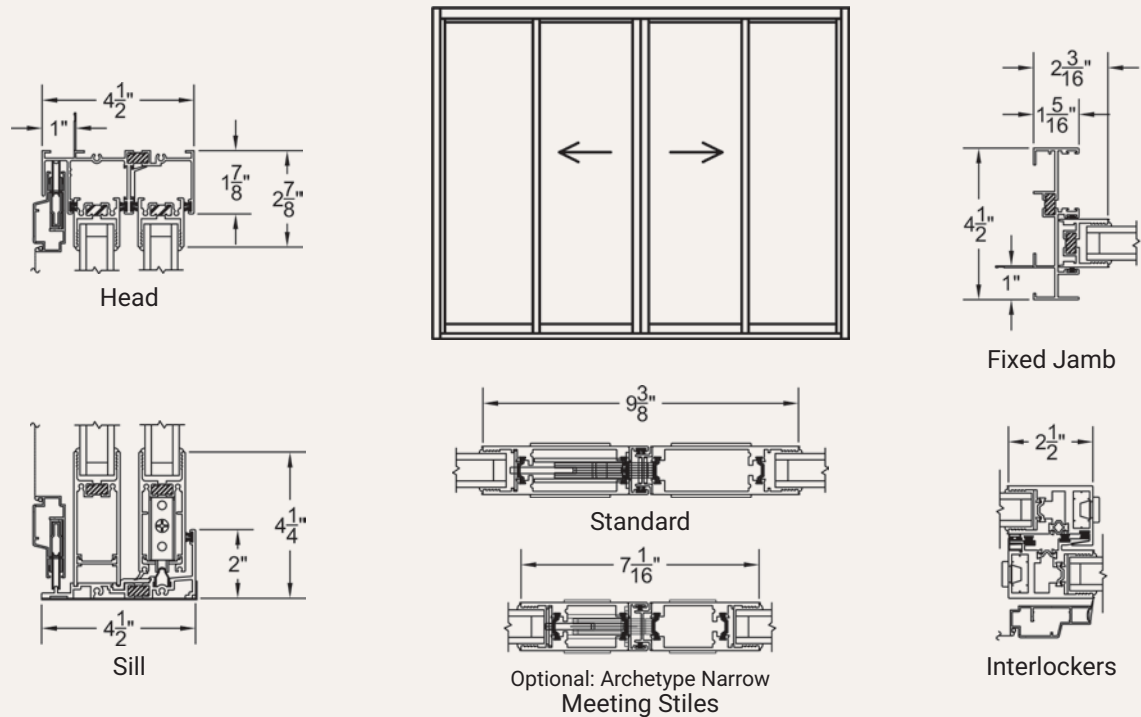

<sup>1</sup>Max width and height are not necessarily available in combination.

<sup>2</sup>Specimen size: Nom. 79" x 79".

<sup>3</sup>Simulated Performance Alternative size: 192" x 120" OXIXO using SNX62/27-IS20/Argon Warm Edge glass.



### THERMAL FRAME EXTRUSIONS

Multi-slide/pocket door systems (3070, 3070-T) are not always needed so we offer the 3000-T for more traditional configurations in colder climates. Using modern technology, each extrusion is engineered to balance aesthetics and performance. The engineering strength is obvious, and detail-minded consumers appreciate the simple and unobtrusive thermal barrier.



### CUSTOMIZATION

The 3000-T can be configured and paired with other products. For example, the false jamb feature allows a center sliding panel or can be used as an "in frame" mullion between a series of fixed panels to create a large opening, i.e. OOOOXOOOO. Additionally, the 4-1/2" frame depth allows the door to be seamlessly mulled to Series 3800-T transoms and sidelites.



### PROPRIETARY TRACK SYSTEM

The Series 3000-T is offered in three threshold heights (1-1/4", 2" & 3") and each comes with an engineered track/roller design. Unlike other designs that use inferior materials or loose track covers, the Fleetwood track insert becomes more stable as weight bears down on it because the concavity of the A2 roller is in perfect harmony to the convex shape of the proprietary stainless steel insert.



### OPTIONAL FEATURES

As with the other Fleetwood sliding doors, the 3000-T is available with several features. High performance verticals can be added to bolster wind load; glass dividers (TDL) can be configured to follow key building lines; an optional sleek, commercial-grade keyed cylinder offers maximum security; and several hardware options accommodate a wide range of needs and aesthetics (see Series 3000).



# SERIES 3000

## SLIDING DOOR



ARCHITECT  
Roman James Design Build  
PHOTO  
Gary Kasi

### TYPICAL CONFIGURATIONS

OX, XO, OXO, OOX, XOO, XOX, OXXO, XOOX.

MAX PANEL WIDTH	MAX FRAME HEIGHT	EXAMPLE SHGC		EXAMPLE U-FACTOR	
17'	14'	<sup>2</sup> NFRC 0.22	<sup>3</sup> S.P.A. 0.24	<sup>2</sup> NFRC 0.47	<sup>3</sup> S.P.A. 0.35

Elevation View:  
OXOL Configuration

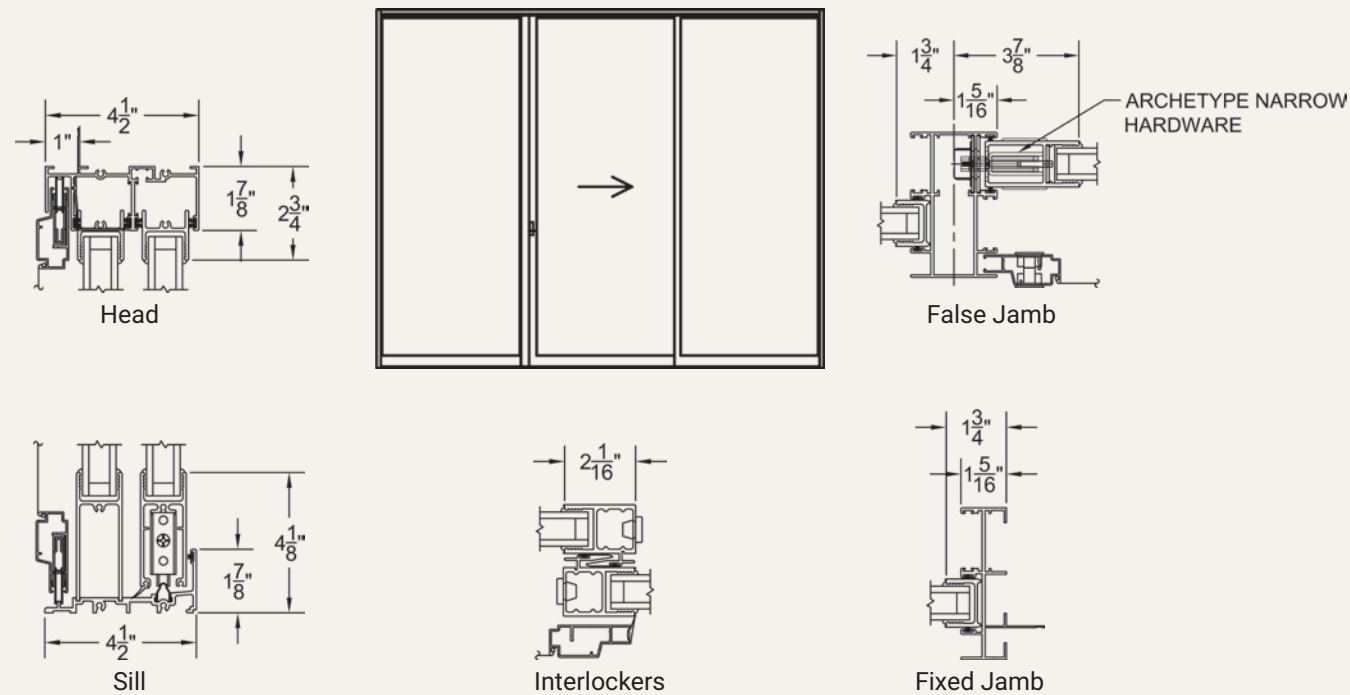

<sup>1</sup>Max width and height are not necessarily available in combination.

<sup>2</sup>Specimen size: Nom. 79" x 79".

<sup>3</sup>Simulated Performance Alternative size: 180" x 130" OXO using SNX62-IS20/Argon Warm Edge glass.



PHOTO  
Pall Rivera Photography

### TRADITIONAL PATIO DOOR

Multi-slide/pocket door systems are not always needed or feasible, so we offer the 3000 and 3000-T for more traditional configurations. These doors fulfill the practical needs of a traditional patio slider but in massive sizes and with much of the same hardware as the Series 3070. Since the vertical sightlines match the multi-slide doors, both blend well in the same project.

### THRESHOLD CHOICES

The 3000 comes standard with a 1-7/8" tall threshold, but the most popular is the 1-1/4", though water performance is lower. If higher water performance is required, we offer a third sill height option at 3".

### SCREEN EXCELLENCE

To most homeowners, screens are a source of irritation because they function poorly and disrupt the view. All Fleetwood products come standard with advanced screen mesh technology by Phifer Inc. Specifically, we use the nearly transparent Ultravue mesh. It is an ideal complement to our sturdy extruded screen frame, which is easy to operate and is made to last for life.

### HANDLE CHOICES

The 3000 comes standard with our patented Archetype locking hardware and recessed pull. If a larger or protruded pull is desired, we offer the Archetype actuator paired with an FSB pull, from which there is a large variety to choose. For those seeking slimmer sightlines, we offer the Archetype Narrow hardware.



# PIVOT & HINGED DOORS





# SERIES 4400-T

PIVOT DOOR



Butler Armsteden Architects  
ARCHITECT  
Jason O'Keefe  
PHOTO

## CONFIGURATIONS

■ H, HH, HHH, HHHH, HHHHH.

← MAX PANEL WIDTH	↑ MAX FRAME HEIGHT	EXAMPLE SHGC		EXAMPLE U-FACTOR	
160"	180"	<sup>2</sup> NFRC 0.33	<sup>3</sup> S.P.A. 0.40	<sup>2</sup> NFRC 0.34	<sup>3</sup> S.P.A. 0.31

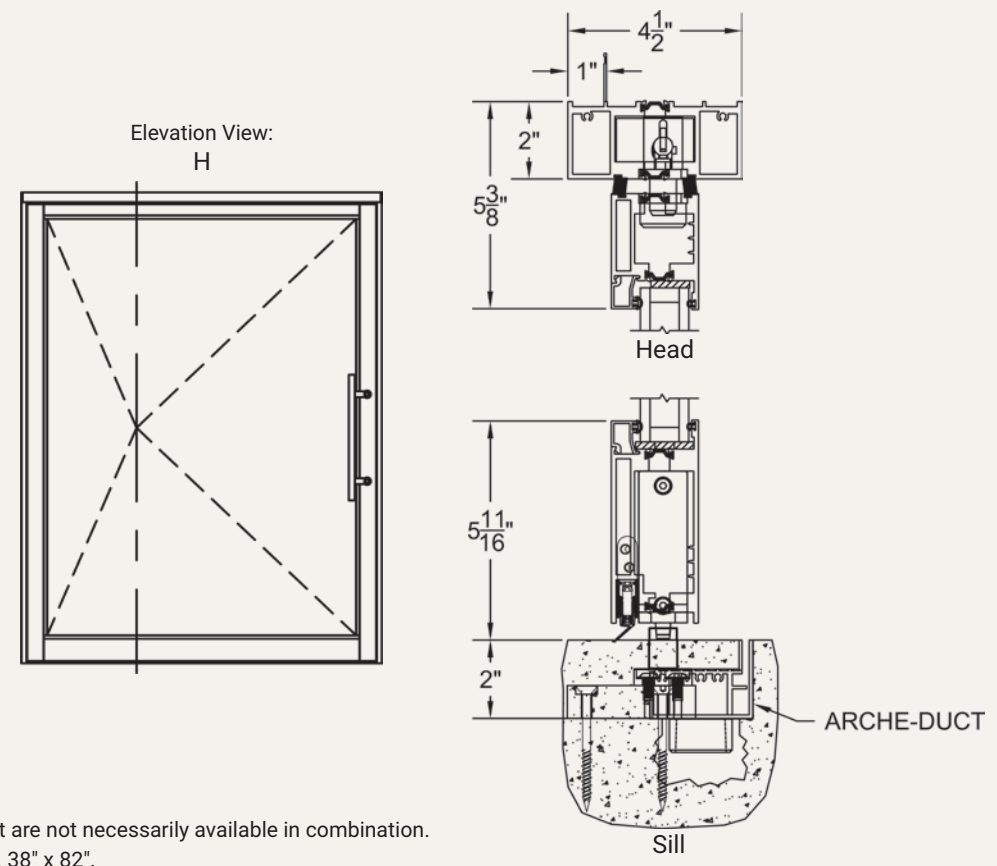

<sup>1</sup>Max width and height are not necessarily available in combination.  
<sup>2</sup>Specimen size: Nom. 38" x 82".  
<sup>3</sup>Simulated Performance Alternative size: 72" x 96" using Cardinal 180/Argon/180/Argon/i89 triple glazing.

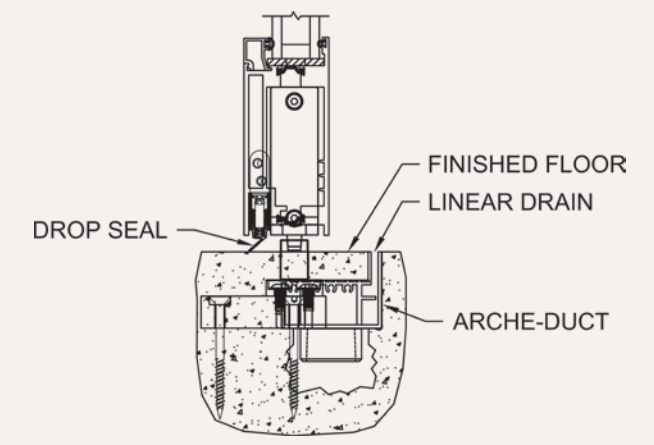

### RESIDENTIAL DESIGN

The first of its kind, the 4400-T breaks serious ground as a weather and energy rated pivot door designed for luxury residential applications. It marries the clean, contemporary design demanded by modern architecture with the performance required by an entrance door. Engineered weather barriers and a concealed drop seal in the bottom rail secure the interior against air and debris infiltration.



### FLUSH FLOOR

The same patented Arche-Duct of the Series 4070-T has been engineered for the 4400-T. Specifically, with the In-Rail Closer (FritsJurgens), the finished floor of the home is part of the pivot door sill, which ONLY reveals a thin jamb-to-jamb slot drain. The end result is a gorgeous flow of interior floors that blurs into the outdoors.



### DESIGN FLEXIBILITY

To suit varied design and operation needs, the 4400-T is offered with several hardware choices. The standard utilizes our proprietary Archetype hardware on a 4" stile operated by an FSB pull. Another option is an integrated 5-point latching system on a 4" stile operated by an FSB lever.



### GO BIG WHEN YOU GO HOME

The strength of the 4400-T allows for incredible sizes that deliver big in both function and drama. Think 15' tall, 1100 lbs. panels with Fleetwood's signature minimal sight-lines and smooth operation.



# SERIES 3900-T

## LUXURY HOME HINGED DOOR



Backen & Gilliam Architects  
Architects  
Adrian Potts

### TYPICAL CONFIGURATIONS

■ H, HH, OH, OOH, OHO, O/HH.

↔ MAX PANEL WIDTH	↑ MAX FRAME HEIGHT	EXAMPLE SHGC		EXAMPLE U-FACTOR	
4.5'	12'	<sup>2</sup> NFRC 0.30	<sup>3</sup> S.P.A. 0.37	<sup>2</sup> NFRC 0.38	<sup>3</sup> S.P.A. 0.27

Elevation View:  
HH Configuration

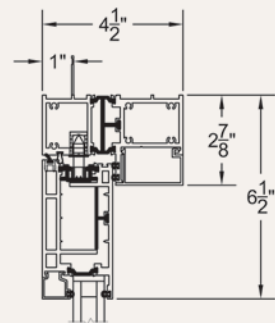

Head

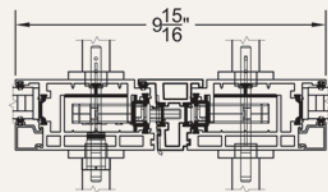
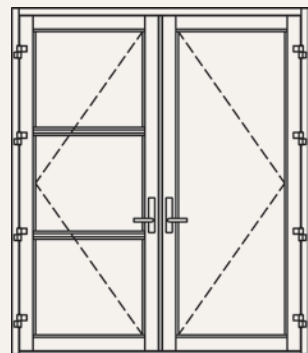

Astragal

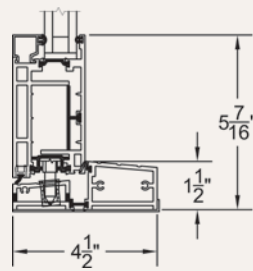

Sill

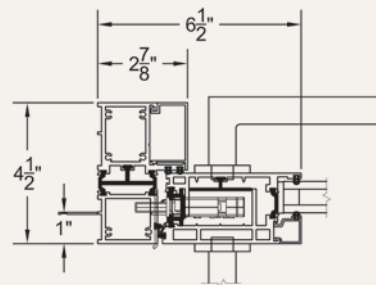

Lock Jamb

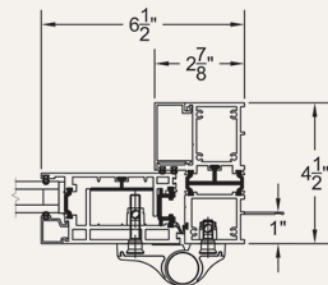

Hinge Side Jamb

<sup>1</sup>Max width and height are not necessarily available in combination.

<sup>2</sup>Specimen size: Nom. 38" x 82".

<sup>3</sup>Simulated Performance Alternative size: 96" x 120" HH using Cardinal 180/Argon/180/Argon/i89 triple glazing.



### WORLD CLASS HARDWARE & KEYLESS ENTRY

Functional and beautiful, the 3900-T comes standard with a 5-point system, which is actuated with a single lever and secured with a robust deadbolt. Homeowners can choose from an assortment of FSB levers in various shapes and finishes. As an option, the door is available with an electronic 3-point keyless entry and locking system.



### VERSATILE OPTIONS

The 4-1/2" frame depth allows for field combinations (sidelites, transoms, etc.) with other Fleetwood products. Fixed sidelites are available in a wide or narrow style. Vents and fixed panels offer the optional insertion of a hopper (in-swing) vent. Available in-swing or out-swing. Depending on foot traffic and weather needs, the 3900-T is offered in 1/2" or 1-1/2" sill heights, or with a flush Arche-Duct sill.



### OUTSTANDING SIZES

Designed for large openings, the 3900-T boasts superior strength with panels as large as 4-1/2' x 12'. Such sizes are possible as a result of the substantial aluminum in each extrusion and the corner bolsting. We use a highly engineered proprietary assembly unlike anything in the industry, complemented by 3-wing adjustable hinges.



### THERMAL TECHNOLOGY

The 3900-T thermal barrier is a modern strut consisting of rigid structural polyamide. Each strut is mechanically fused to two separate aluminum shapes to form one extrusion. The result is significantly minimized thermal conduction of the exterior temperature to the interior. We use this technology because it offers design flexibility without compromising thermal performance.



# SERIES 3200-T

NARROW STYLE HINGED DOOR



ARCHITECT  
 Kennedy Architecture  
 PHOTO  
 Adam Polts

## TYPICAL CONFIGURATIONS

■ H, HH, OH, OOH, OHO.

MAX PANEL WIDTH	MAX FRAME HEIGHT	EXAMPLE SHGC		EXAMPLE U-FACTOR	
40"	108"	<sup>2</sup> NFRC 0.14	<sup>3</sup> S.P.A. 0.15	<sup>2</sup> NFRC 0.34	<sup>3</sup> S.P.A. 0.29

Elevation View:  
H Configuration

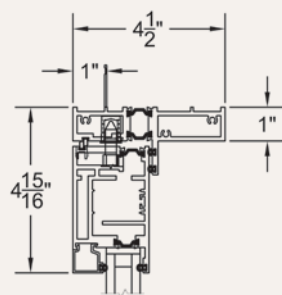

Head

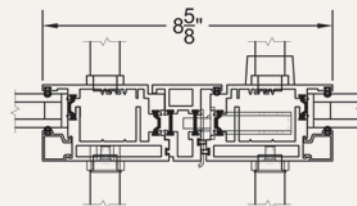
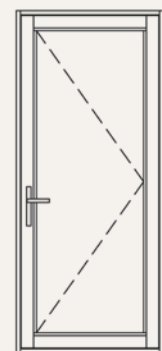

Astragal  
(Paired Doors)

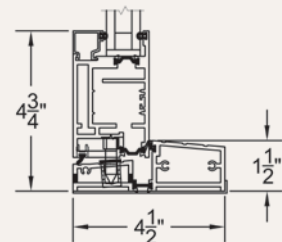

Sill (Out-Swing)

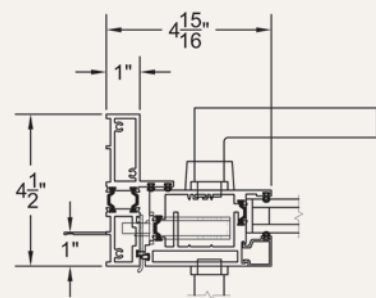

Lock Jamb

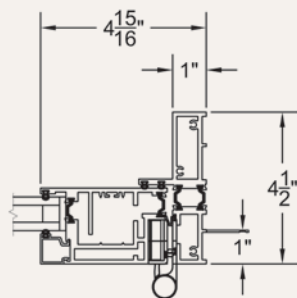

Hinge Side Jamb

<sup>2</sup>Specimen size: Nom. 38" x 82".

<sup>3</sup>Simulated Performance Alternative size: 72" x 108" HH using SNX62/Argon/SNX62/Argon/IS20 Warm Edge triple glazing.



## STEEL LOOK

The 3/4" Steel Look SDL and Lockbox simulate a classic steel hinged door without the cost and challenges of steel. The Steel Look package is complete when combined with the 350-T and 3800-T.

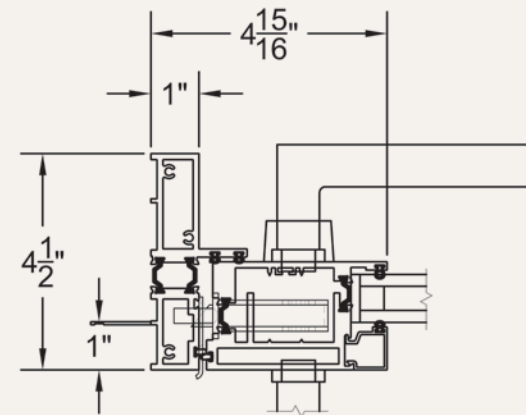

## SLENDER YET STRONG

The 3200-T boasts a jamb profile of less than 4" after the frame is buried. Additionally, the horizontal rails have been reduced to provide the least sightline possible. Though slim, the 3200-T is a bulwark door with its heavy aluminum walls and a corner assembly similar to the 3900-T.



## MINIMALIST HARDWARE

The FSB hardware selected for the 3200-T has a slimmer handle plate than the Series 3900-T, but allows the same lever options. The door self-latches when closed and is secured with a dead bolt. The passive panel in a pair comes with a flush mounted concealed lever that operates two shoot bolts.



## ADJUSTABLE HINGES & LARGE SIZES

Each operable panel is equipped with four adjustable hinges that are mortised into the frame. Though slender in profile, the hinges easily support panels as large as 40" x 108".



# SERIES 3600-T

## FOLDING DOOR



Koss design+build  
ARCHITECT  
Roehner + Ryan  
PHOTO

### CONFIGURATIONS

Any combination of left and right panels, up to 8 in either direction; Corner applications.

MAX PANEL WIDTH	MAX FRAME HEIGHT	EXAMPLE SHGC		EXAMPLE U-FACTOR	
3.5'	12'	<sup>2</sup> NFRC 0.20	<sup>3</sup> S.P.A. 0.21	<sup>2</sup> NFRC 0.34	<sup>3</sup> S.P.A. 0.31

Elevation View:  
1L3R

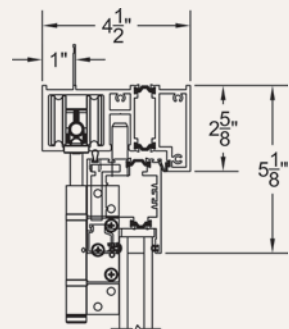

Head

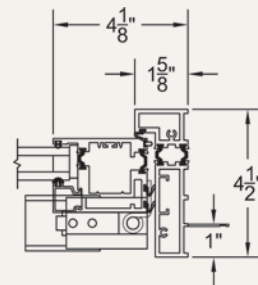

Pivot Jamb

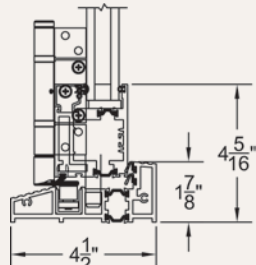

Standard

Sill

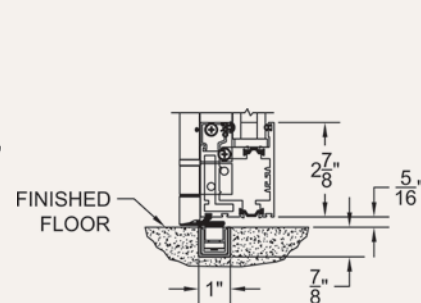

Optional: Flush Sill Guide

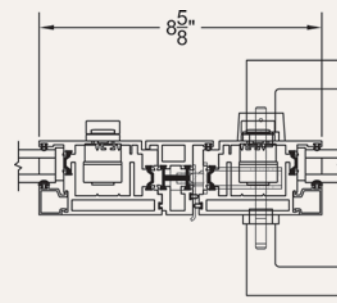

Meeting Stiles  
(Integral Hinged Door)

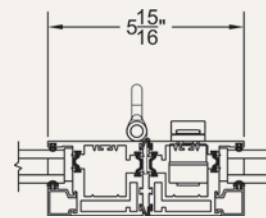

Hinged Handle & DPL

<sup>1</sup>Max width and height are not necessarily available in combination.

<sup>2</sup>Specimen size: Nom. 75" x 82".

<sup>3</sup>Simulated Performance Alternative size: 144" x 120" 1L3R using Cardinal 366-i89/Argon glass.



### STAINLESS DUAL POINT LOCK

Every folding pair comes standard with our stainless steel Dual Point Lock (DPL). Each DPL throws two stainless steel shoot bolts into the respective tracks to offer high security. Its modern design is an ideal complement to the 3600-T.



### COASTAL PROJECTS & ZERO EDGE CORNERS

Most folding doors on the market are offered with hardware that will fail in salt air. In contrast, the 3600-T is designed for such environments. Our stainless steel Dual Point Lock, carriers, hinges, and locking hardware provide longevity in the most extreme conditions. To help expand amazing coastal views, we offer a 90-degree corner configuration with NO vertical posts.



### INTEGRATED PASSAGE DOOR

Customers can insert a hinged door within a folding wall. The locking hardware chosen for such doors is FSB, selected for its style and exceptional performance.

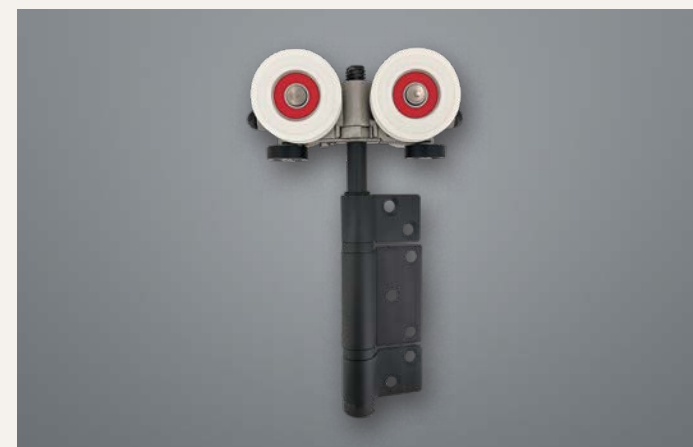

### CARRIERS

The 3600-T glides on Brio carriers, which are the most modern folding door technology. Each intermediate panel has four high performance wheels with two side thrust precision bearings. These four wheels provide unparalleled stability, as well as smooth and quiet operation. Additionally, each wheel is concaved to improve tracking.



# WINDOWS





# SERIES 450-T

CASEMENT • AWNING • HOPPER • FIXED



## CUBE DESIGN

Our design engineers needed two years to create our next generation casement window, and the result is architectural excellence. The wall-to-glass dimension at only 2-9/16" is the slimmest on the market. An added element is its modern cube appearance and how the frame and vent intersect to eliminate distracting transitions of metal and vinyl.



## ARTISTIC SYMMETRY

One feature of the cube design is a 3/16" shadow line that traces the interior and exterior. The sill shadow line is also functional, as it conceals weep slots and provides a linear drain. The complementary fixed window system carries this shadow line at the exterior for a consistent linear progression when combining operable and fixed on the same elevation.



## CONVECTION BLOCKERS

The 450-T was created with 'convection blockers' to maximize the natural insulation of air. The blockers are comprised of low thermal conductivity materials and divide the extruded hollows into smaller chambers, thereby slowing thermal conductivity. Combined with our proprietary strut, the 450-T is an exceptional energy performer.



## PROPRIETARY CAM HANDLE & MULTI-POINT LATCH

The Archetype Multi-Point Latch was engineered for the 450-T as the perfect complement to the Archetype Cam Handle. Both were designed with an ideal balance of minimal design and ergonomics. Made from high-grade stainless steel and crafted with care, together they are a work of art that complement the crisp and linear shapes of the 450-T.



### TYPICAL CONFIGURATIONS

- C, CC, COC, A, AA, AOA, H, HH, O-GTF, OO-GTF.
- Maximum Panel Square Footage: Casement, Awning & Hopper: 24 ft<sup>2</sup>.
- Partner Products: Series 3800-T Fixed System.

EXAMPLE SHGC		EXAMPLE U-FACTOR	
<sup>2</sup> NFRC	<sup>3</sup> S.P.A.	<sup>2</sup> NFRC	<sup>3</sup> S.P.A.
0.26	0.30	0.23	0.22

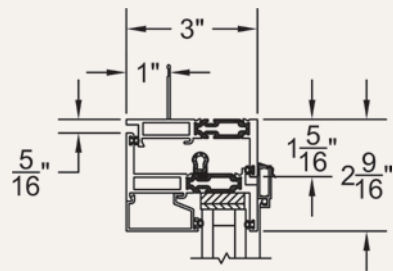

Casement Head

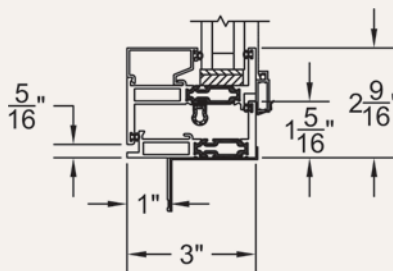

Casement Sill

Elevation View: C

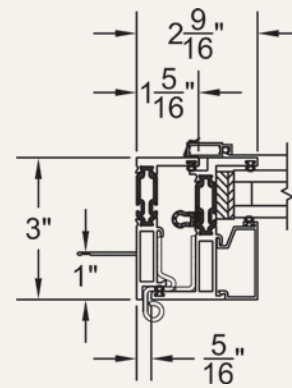
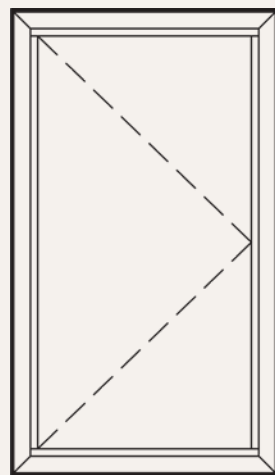

Hinge Side Jamb

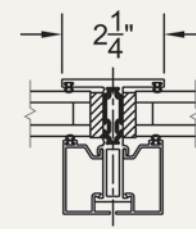

TDL

<sup>2</sup>Specimen size: Nom. 24" x 59".

<sup>3</sup>Simulated Performance Alternative size: 48" x 72" casement using Cardinal 272/Argon/Clr/Argon/180 triple glazing.



# SERIES 350-T

CASEMENT • AWNING • HOPPER • FIXED



## STEEL LOOK APPLIED GRID

The 350-T, as well as several other products, offers this feature, which resembles the classic look of a steel window, yet retains all the advantages of aluminum.

## HINGED SCREEN

This heavily engineered screen features a magnetic keeper & latch, and neoprene bulb as the bug guard. This feature is only offered with the cam handle/4-bar hinge option, which is what the factory recommends for coastal and high wind projects.

## NARROW BUTT HINGES

Each casement butt hinge is 3" long, 7/16" in diameter, and constructed of 316 stainless steel. For maximum coastal protection, each hinge is electropolished and then brush finished or powder coated. For an even cleaner profile, we offer a concealed stainless steel 4-bar hinge with cam handle hardware.

## WELDED CORNERS

Typical residential casement windows have screw-joined corners, which weaken over decades as the windows are operated. However, Fleetwood welds the vent corners for lifetime performance. For added strength, each corner includes an aluminum extruded corner key that is crimped using a hydraulic press and welded into place.

### TYPICAL CONFIGURATIONS

- C, CC, COC, A, AA, AOA, H, HH, O-GTF, OO-GTF.
- Maximum Panel Square Footage: Casement, Awning & Hopper: 24 ft<sup>2</sup>
- Partner Products: Series 3800-T Fixed System.

EXAMPLE SHGC		EXAMPLE U-FACTOR	
<sup>2</sup> NFRC	<sup>3</sup> S.P.A.	<sup>2</sup> NFRC	<sup>3</sup> S.P.A.
0.14	0.15	0.39	0.34

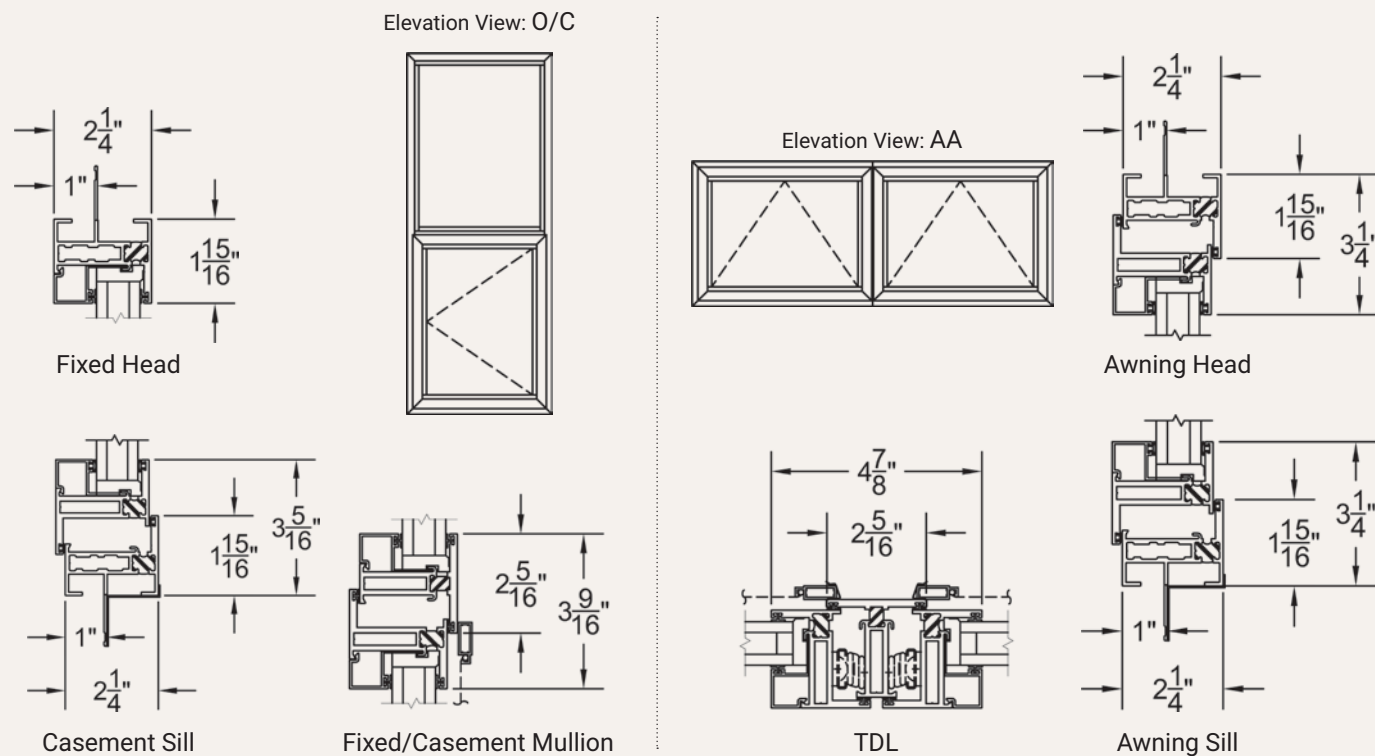

<sup>2</sup>Specimen size: Nom. 59" x 24".

<sup>3</sup>Simulated Performance Alternative size: 72" x 36" awning using SNX62/Argon/SNX62/Argon/IS20 triple glazing.



# SERIES 3800-T

## WINDOW-WALL FIXED SYSTEM



Scott Edwards Architecture  
Pete Eckert

### TYPICAL CONFIGURATIONS

- Virtually Unlimited.
- Optional Inserts (Casement, Awning, Hopper, Fixed, Screen).

↔ MAX PANEL WIDTH	↕ MAX FRAME HEIGHT	☀ EXAMPLE SHGC	❄ EXAMPLE U-FACTOR
Determined by Site Wind Loads	Determined by Site Wind Loads	0.17 <sup>2</sup> NFRC	0.2 <sup>2</sup> NFRC

Elevation View:  
Window-Wall With Operable Inserts

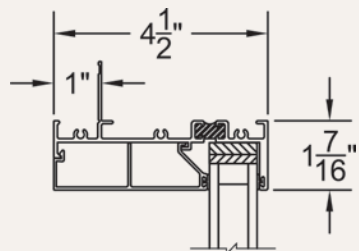

Head

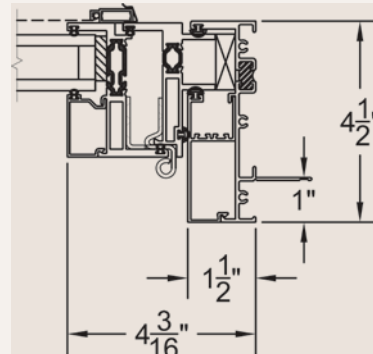
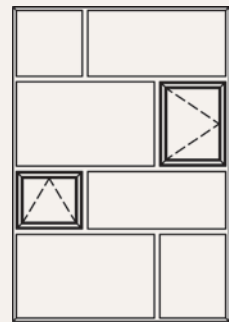

Jamb With 450-T Insert

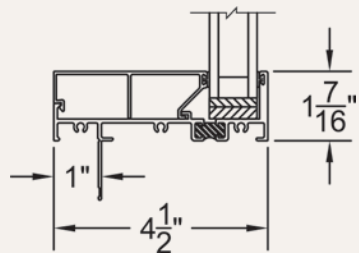

Sill

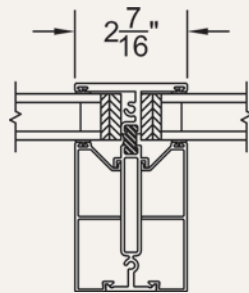

TDL

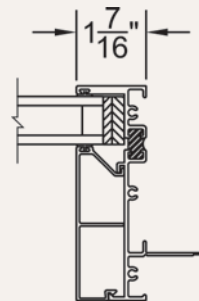

Jamb

<sup>2</sup>Specimen size: Nom. 47" x 59".



### LUXURY STANDARDS

Luxury homes demand finer details than those offered by commercial storefront products. Such systems are field fabricated, including field drilled weeps. Storefront also relies on field packed rubber into all seams and joints, resulting in uneven sightlines and gaps. In stark contrast, the 3800-T has factory punched, rectangular weep slots and meets the high fit and finish standards of elite luxury.



### NARROW SIGHT-LINES

The most popular feature of the 3800-T is its thin perimeter sight-line of 1-7/16" (block or nail-fin frame). Customers can choose from either an inside glaze or outside glaze orientation.



### STEEL LOOK WINDOW

The Series 3800-T is offered with a simulated divided lite which resembles a classic steel window beveled design. This allows the "Steel Look" without the inherent complications and limitations of steel products.



### INSERTS & MULLING

The 3800-T offers limitless configurations and the ability to insert window and door panels. Additionally, the 4-1/2" frame depth lines up perfectly with most other Fleetwood doors for seamless field mulling.



# SERIES 330-T

HORIZONTAL SLIDER • FIXED



Anthony Barredo PHOTO

## TYPICAL CONFIGURATIONS

- XO, OX, XOX, O-GTF, OO-GTF.
- Maximum Panel Width<sup>1</sup>: '6.5'.
- Maximum Panel Height<sup>1</sup>: '6'.

↔ MAX PANEL WIDTH	↕ MAX FRAME HEIGHT	☀ EXAMPLE SHGC	❄ EXAMPLE U-FACTOR
'6.5'	'6'	<sup>2</sup> NFRC 0.21   <sup>3</sup> S.P.A. 0.23	<sup>2</sup> NFRC 0.36   <sup>3</sup> S.P.A. 0.29

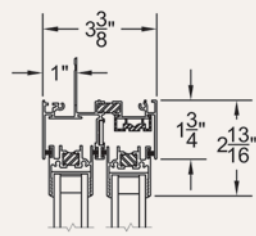

Head

Elevation View: XO

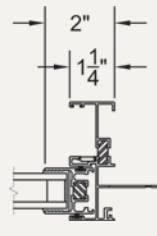
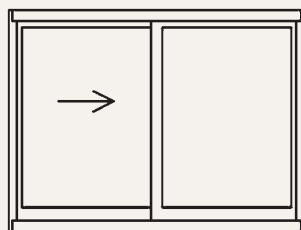

Fixed Jamb

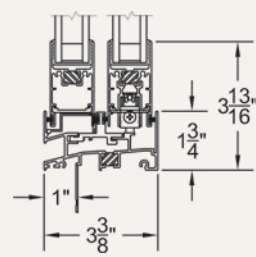

Sill

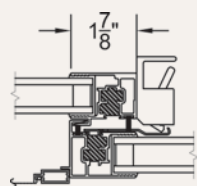

Interlockers

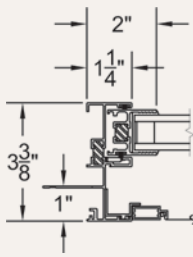

Lock Jamb



## DESIGNER LATCH

True to Fleetwood form, the 330-T is equipped with our proprietary latch, proudly made in the USA and constructed of 316 stainless steel. It is a self-latching design so you only need close the window to be sure it is securely locked. This latch is available in brushed or black painted stainless steel.

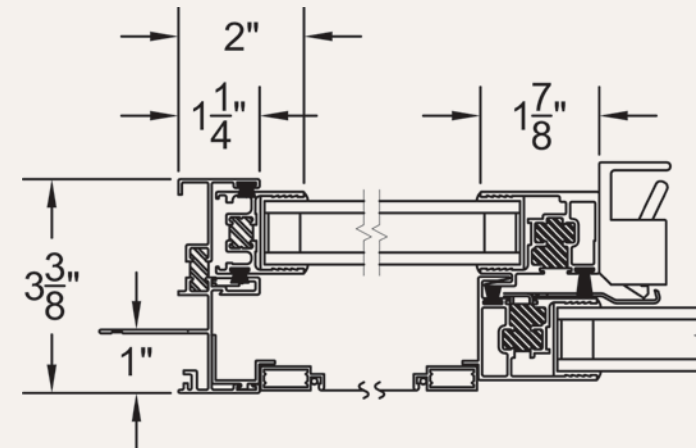

## ENCAPSULATED SCREEN

Most windows on the market have screens that jut out from the main frame. Fleetwood's screens are captured within the frame depth, creating a clear and sleek appearance.

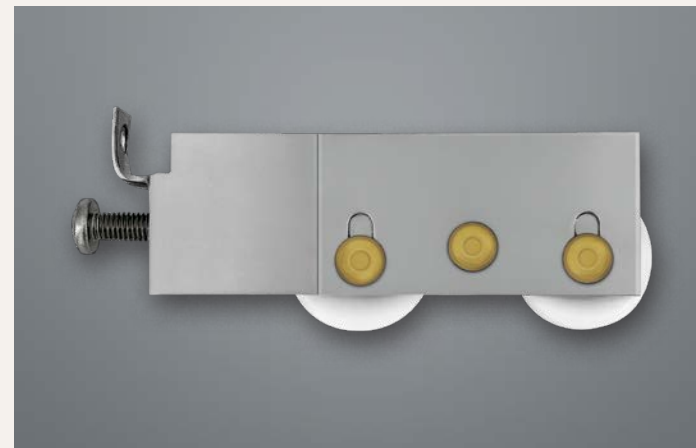

## TANDEM ROLLERS

The 330-T rolling system stands alone in the market as the only sliding window with an adjustable tandem roller. This small but capable roller is constructed of stainless steel with nylon tires, and can carry up to 75 pounds of weight.



## HIGH PERFORMANCE CAPABILITY

For applications requiring high performance windows, the 330-T has the answer with a variety of options that increase its strength, including an HP integral stack bar and a high water sub sill.

<sup>1</sup>Max width and height are for horizontal sliders and are not necessarily available in combination.

<sup>2</sup>Specimen size: Nom. 59" x 47".

<sup>3</sup>Simulated Performance Alternative size: 144" x 90" XO using Cardinal 366-i89/Argon glass.



# DOOR HARDWARE

Most Fleetwood hardware is crafted in the USA from high-grade stainless steel (S.S.) and several parts are treated with an electropolished finish for paramount coastal protection. All hardware shown is brushed texture, except where otherwise noted.

## ARCHETYPE LOCKING SYSTEM

MULTI-SLIDE/POCKET DOORS: SERIES 4070-T, 3050, 3070-T, 3070, 3070-HI

TRADITIONAL SLIDING DOORS SERIES 3000-T, 3000



Archetype - S.S.    Archetype - S.S. (Black Powder Coat)    Archetype Narrow - S.S.    Archetype Narrow - S.S. (Black Powder Coat)    Strike Plate - S.S.

## ARCHETYPE ROLLERS & TRACK



A4 - S.S. Swiss Precision Bearings (Series 4070-T)    A2 - S.S. 2" diameter Swiss Precision Bearings (Series 3050, 3070-T, 3070, 3000-T, 3000)    Track Insert - S.S. (Shown in 2 track 3070 sill)

## ARCHETYPE MULTI-SLIDE DOOR OPTIONS

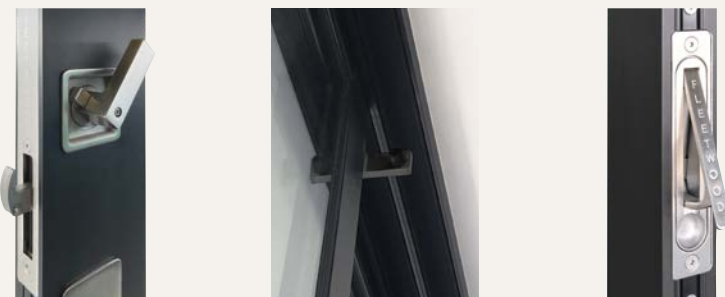

Actuator Lever - S.S.    Door Collectors - S.S.    Edge Pull - S.S.

## HINGED DOOR: SERIES 3900-T



FSB Lever #1076 - S.S.    FSB Lever #1075 - S.S.    FSB Lever #1005 - S.S.    Savio Butt Hinges - Aluminum (Finished to match)

## HINGED DOOR: SERIES 3200-T



FSB Lever #1076 - S.S.    Flush Bolt Latch    Adjustable Hinge - S.S. (PVD Finish)

## PIVOT DOOR: SERIES 4400-T



FritsJurgens In-Rail Closer - S.S.    Archetype Floor Pivot - S.S. (Black Powder Coat)    Rixson Floor Closer

## FOLDING DOOR: SERIES 3600-T

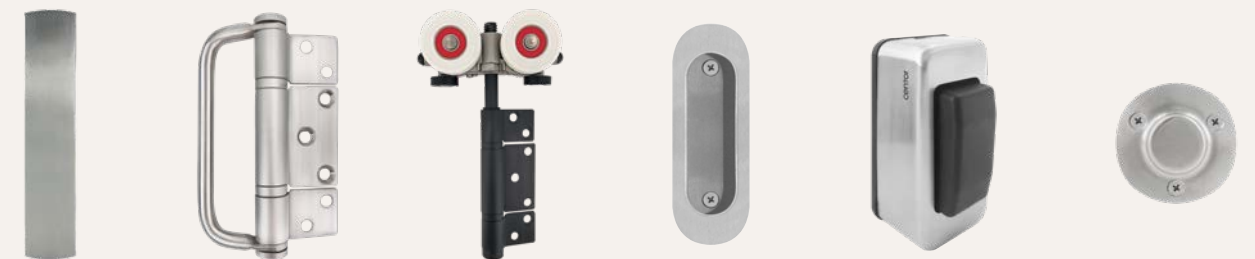

DPL Handle - S.S.    Hinge Handle - S.S.    Intermediate Carrier - S.S.    Flush Pull - S.S.    Hinged Door Holder    Collector Magnet - S.S.



# WINDOW HARDWARE

Most Fleetwood hardware is crafted from high-grade stainless steel (S.S.) and several parts are treated with an electropolished finish for paramount coastal protection. All S.S. hardware shown is brushed texture. Some components are available in black.

## CASEMENT



Cam Handle - S.S.  
(4-Bar Hinges)  
(Series 450-T)



Multi-Point Latch - S.S.  
(Series 450-T)



Folding Rotogear<sup>1</sup>  
(Butt Hinges)  
(Series 450-T & 350-T)



Cam Handle - S.S.  
(4-Bar Hinges)  
(Series 350-T)



Multi-Point Latch<sup>1</sup>  
(Series 350-T)

## CASEMENT, AWNING & HOPPER: HINGES



Butt Hinge - S.S.  
(Series 450-T)



HP Butt Hinge - S.S.  
(Series 450-T)



4-Bar - S.S.  
(Series 450-T & 350-T)



Butt Hinge - S.S.  
(Series 350-T)

Availability of hinges is based on operator type.

## AWNING



Cam Handle - S.S.  
(4-Bar Hinges)  
(Series 450-T)



Multi-Point Latch - S.S.  
(Series 450-T)



Folding Rotogear<sup>1,2</sup>  
(4-Bar Hinges)  
(Series 450-T & 350-T)



Cam Handle - S.S.  
(4-Bar Hinges)  
(Series 350-T)



Multi-Point Latch<sup>1</sup>  
(Series 350-T)

## SCREENS



Hinged Screen  
(Series 450-T & 350-T Casement & Awning)



Flat & Sliding Window Screen  
(Series 450-T, 350-T, 330-T)

## HOPPER



Spring Latch - S.S.  
(4-Bar Hinges)  
(Series 450-T & 350-T)



Ring Pole  
(Series 450-T & 350-T)

## HORIZONTAL SLIDER



Strike & Latch - S.S.  
(Series 330-T)



Roller - S.S.  
(Series 330-T)

<sup>1</sup> Cast zinc (plated finish).

<sup>2</sup> Limited vent travel.



# ALUMINUM FINISHES

One of the unique traits of aluminum is its ability to be finished using multiple techniques, including anodizing and painting. If properly maintained, these finishes will last a lifetime. We offer more information on our website (Homeowners/Right Choices).

**ANODIZING** is a permanent chemical conversion process. Aluminum extrusions are exposed to a series of electrochemical baths, which create a hard, protective layer that can be left 'clear' or organically dyed to Light Bronze, Medium Bronze, and Black colors. While anodizing cannot be as visually uniform as paint, it yields a much richer and livelier depth of color and finish.

The custom Light Bronze and Medium Bronze colors (below) inherently exhibit color variation from part-to-part, as well as color-shifting depending upon viewing angle and lighting. Anodized finishes are always at least somewhat transparent and therefore expose underlying aluminum grain and character similar to a stain-finish on wood. As such, an acceptance range is necessary for these two colors (see range below). If color uniformity is required on your project, Fleetwood offers 70% Kynar painted finishes (opposite page).

## STOCK ANODIZED FINISHES

Fleetwood offers two stock anodized colors:

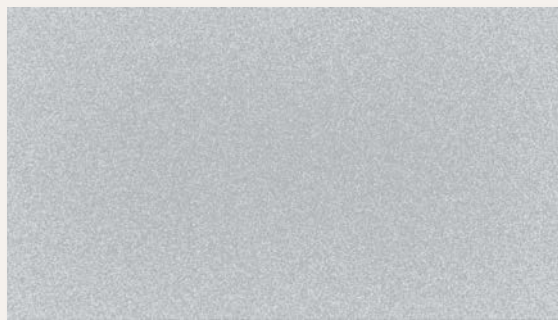

Class I Clear

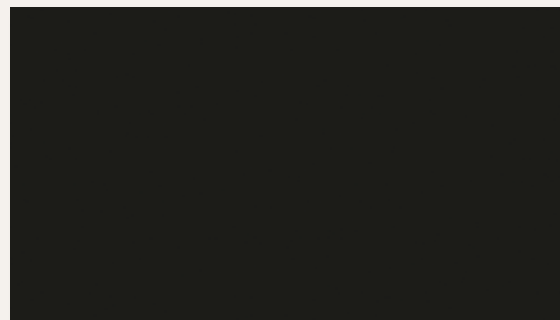

Class I Black

## CUSTOM ANODIZED FINISHES

Fleetwood offers two custom anodized colors.

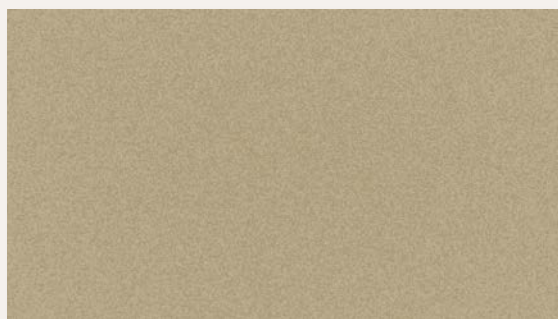

Class I Light Bronze



Class I Medium Bronze



The anodized colors shown above are **not actual anodize**, but resemble the anodized colors as closely as possible within the limitations of printed reproduction. Actual anodized samples are available upon request.

The **PAINTING** Fleetwood offers is a process involving high performance liquid paint (Kynar 500®) and an electrostatic process for even coverage. Other aluminum products are painted with powder coating but it may not be as attractive as Kynar 500®, whose high-performance fluoropolymer resin has an extraordinary capability to retain color and gloss while keeping painted metal looking vibrant and appealing. Consider that there are thousands of powder coaters but only a handful of applicators licensed to spray Kynar 500®.

## THOUSANDS OF COLORS!

Custom paint is available in a limitless rainbow of colors and sheens. Choose from the Favorite Colors shown below, use a color name and UC number from a paint catalog, or provide us with a physical sample of the desired color. During confirmation of your order, we will furnish an aluminum color sample for your review and approval.

## PAINTED ALUMINUM FINISHES | 12 OF OUR CUSTOMERS' FAVORITE COLORS

Kynar 500® (Kynar 70%\* Standard 2-Coat)

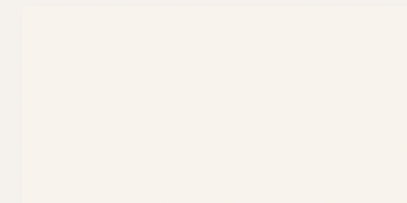

#10 White

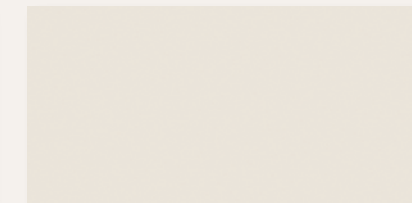

Bone White

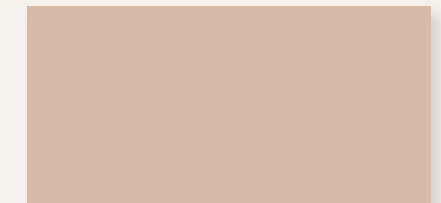

Beige



Light Seawolf



Medium Bronze

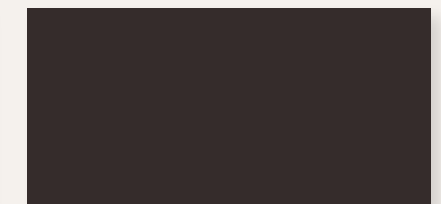

#50 Statuary Bronze



Fashion Gray



Charcoal Gray

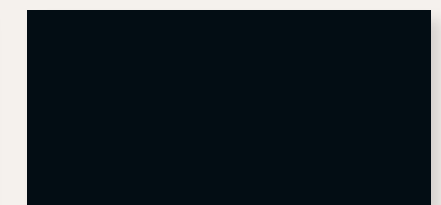

#50 Black

Kynar 500® Specialty Coatings (Kynar 70%)

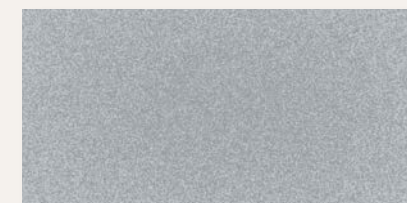

Silver, Mica 2-Coat

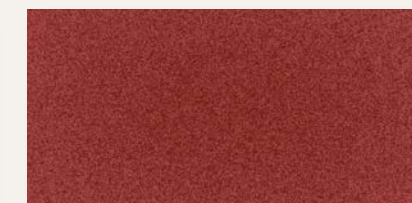

Brite Copper, Metallic 4-Coat

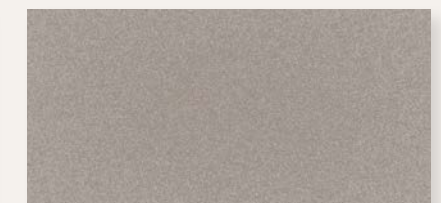

Champagne Sunstorm, Mica 2-Coat

The painted colors shown above are **not actual paint**, but resemble the painted colors as closely as possible within the limitations of printed reproduction. Actual painted samples are available upon request.

Kynar 500® is a registered trademark of Elf Atochem North America, Inc. Minimum of 70% fluoropolymer resin for premium performance in solid colors. Two-coat system: Corrosion inhibiting primer at 0.2 mil and durable high performance topcoat at 1.0 mil. Minimum total dry film thickness of 1.2 mil. Hardness: F minimum. Meets or exceeds AAMA 2605. Gloss: Medium (25-35 @ 60).

\* Dark colors (ex. Black) are standard with 50% fluoropolymer resin. See "Paint & Finishes" on FleetwoodUSA.com for more info.



# SUSTAINABILITY

Fleetwood creates the most sustainable products on the market, made possible by both our material of choice and our manufacturing methods.



## ALUMINUM

As the most abundant, naturally occurring metal in the Earth's crust, aluminum rates highest in Life Cycle Assessment and offers infinite recyclability. The recycling process requires minimal energy, and the recycled product is identical to the virgin product, with no degradation in properties.

Aluminum rates exceptionally high in a strength-to-weight ratio, and possesses tremendous formability, allowing complex shapes.

## PERFORMANCE

Aluminum has a natural, protective hard oxide coating. When finished with anodizing or painting, the result is superb corrosion resistance, even with prolonged exposure to harsh environments.

Our finishing processes – whether anodizing or painting – create a highly corrosion resistant product that is free of Volatile Organic Compounds. Maintenance requirements are low, and if cared for properly, the finishes can last a lifetime, minimizing wasted energy on redundant manufacturing of shorter-lived materials.

## MANUFACTURING

Fleetwood recycles 100% of the remnants generated during the manufacturing process. The scrap is collected and returned to the supply source, limiting waste.

The entire manufacturing facility is powered by a high-performance photovoltaic system, generating more than 8,000,000 kWh of emissions-free electricity.

# FACTORY & SHOWROOM

We invite you to visit our 207,000 square foot factory which is located in Southern California. Our Showroom is equipped with a broad sampling of every product we manufacture. Contact one of our authorized dealers to schedule an appointment.



## FINDING A DEALER

If your project is located in one of our major markets, you can find a local dealer using the Dealer Showroom Search tool on our website.

## IMPORTANT

The Transferable Lifetime Warranty and Care & Maintenance Instructions are available online. We encourage you to visit our website at [www.FleetwoodUSA.com](http://www.FleetwoodUSA.com).

## CONFORMANCE







**Fleetwood Windows & Doors**

1 Fleetwood Way, Corona, CA 92879  
P.O. Box 1086, Corona, CA 92878-1086

800.736.7363  
951.279.1070

[www.FleetwoodUSA.com](http://www.FleetwoodUSA.com)  
[Sales@FleetwoodUSA.com](mailto:Sales@FleetwoodUSA.com)

DISTRIBUTED BY: